

Electronics-Salon

Passive Bistable(Latching) DPDT 8A Power Relay Module

Version List

One relay without DIN rail mount housing:

MD-D262/5V, MD-D262/12V, MD-D262/24V.

One relay with DIN rail mount housing:

MD-D262T/5V, MD-D262T/12V, MD-D262T/24V.

Two relay without DIN rail mount housing:

MD-D263/5V, MD-D263/12V, MD-D263/24V.

Two relay with DIN rail mount housing:

MD-D263T/5V, MD-D263T/12V, MD-D263T/24V.

Four relay without DIN rail mount housing:

MD-D264/5V, MD-D264/12V, MD-D264/24V.

Four relay with DIN rail mount housing:

MD-D264T/5V, MD-D264T/12V, MD-D264T/24V.

Module

Picture

MD-D262
5V 12V 24V



MD-D262T
5V 12V 24V

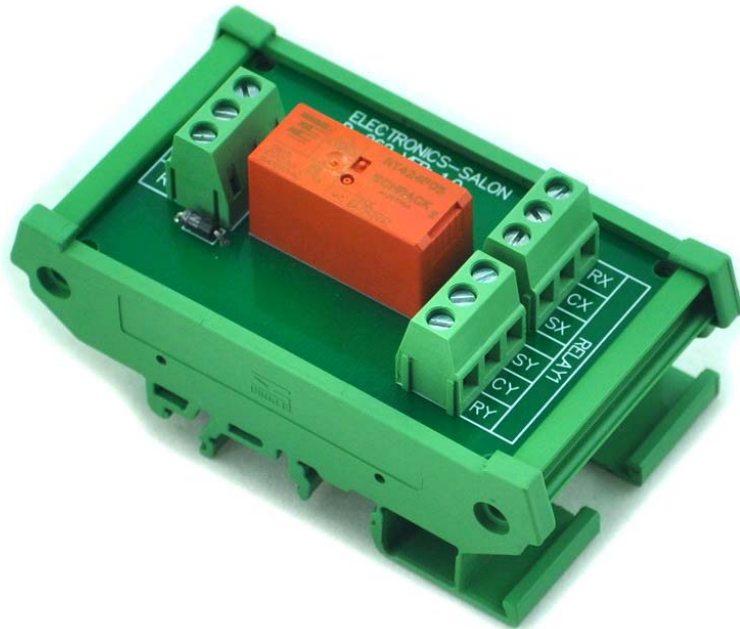

MD-D263
5V 12V 24V

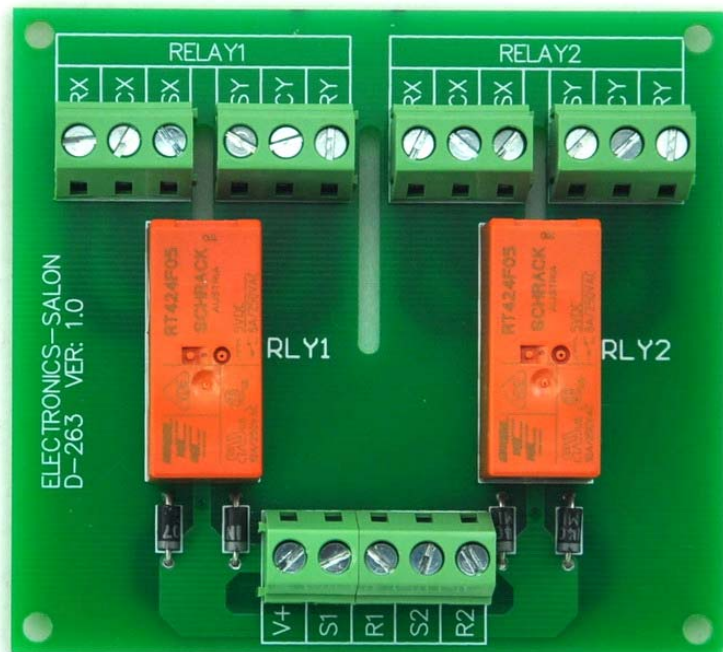

MD-D263T
5V 12V 24V

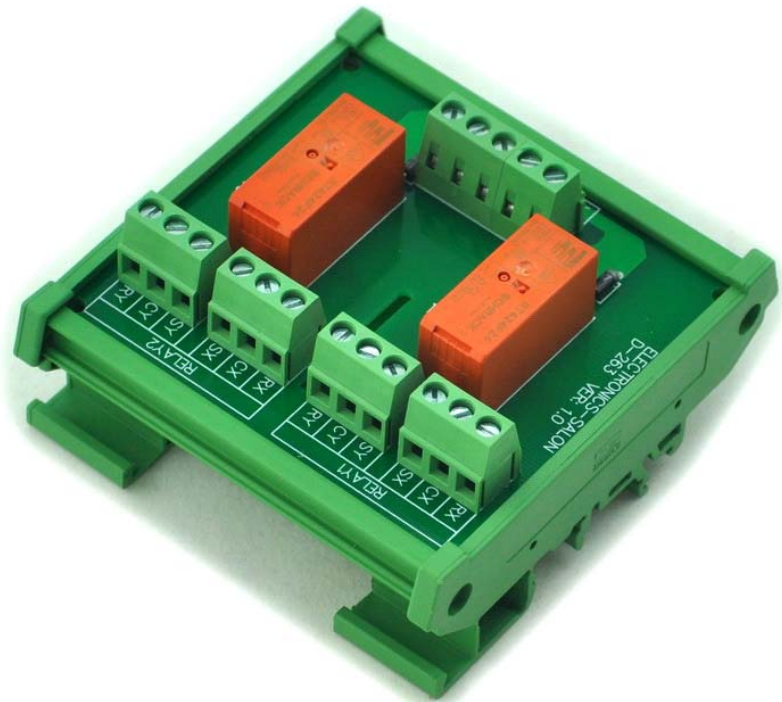

MD-D264
5V 12V 24V



MD-D264T
5V 12V 24V

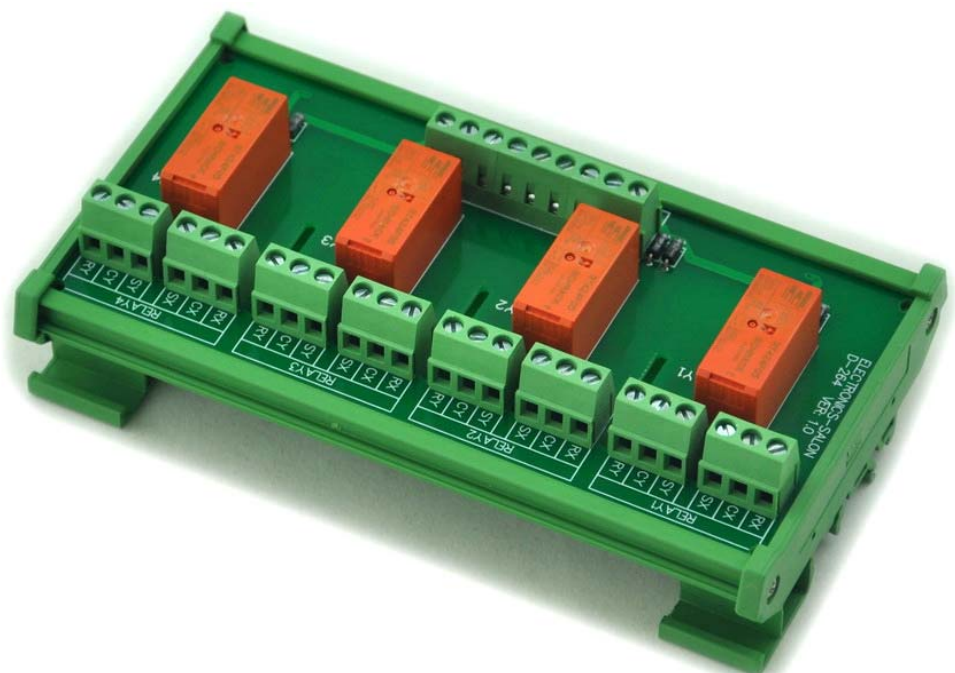

Passive Bistable(Latching) DPDT 8A Power Relay Module

Bistable(Latching) relay is a special kind of relay. These are also called "impulse", "keep" or "stay" relays. When the current is switched off, the relay remains in its last state. While a conventional relay uses power continuously when its internal switch is to be closed (relay coil energized), a latching relay require only a brief voltage pulse to change state. The relay will maintain its state when the power supply removed.

Typical applications:

Battery powered equipment or applications with "memory function".

Relay type	TYCO RT2 series bistable power relay. 5V version: RT424F05 12V version: RT424F12 24V version: RT424F24
Operating current (single relay action)	5V version: 119mA 12V version: 50mA 24V version: 27Ma
Operating voltage range	5V version: DC 3.5 ~ 7.5V. 12V version: DC 8.4 ~ 18V. 24V version: 16.8 ~ 36V.
Size (L x W x H) D-262/xx D-262T/xx D-263/xx D-263T/xx D-264/xx D-264T/xx	47.4 x 72.5 x 20 mm 50 x 87 x 41 mm 80 x 72.5 x 20 mm 83 x 87 x 41 mm 150 x 72.5 x 20 mm 153 x 87 x 41 mm

Switch contact data:

Contact arrangement	DPDT (2 form C)
Rated voltage	250VAC
Max. switching voltage	400VAC
Rated current	8A, UL 10A

Limiting continuous current	8A, UL 10A
Limiting making current (max. 4s)	15A
Breaking capacity max.	2000VA

Control terminal block:

V+: relay coil common terminal.

R: relay reset action signal input.

S: relay set action signal input.

Switch terminal blocks:

Rx / Cx / Sx: Switch X.

Ry / Cy / Sy: Switch Y.

When the input trigger signal R is Low(pulse or constant):

Switch X, Rx – Cx is connected and Cx – Sx is disconnected.

Switch Y, Ry – Cy is connected and Cy – Sy is disconnected.

When the input trigger signal S is Low(pulse or constant):

Switch X, Rx – Cx is disconnected and Cx – Sx is connected.

Switch Y, Rx – Cx is disconnected and Cx – Sx is connected.

Schematic(one relay):

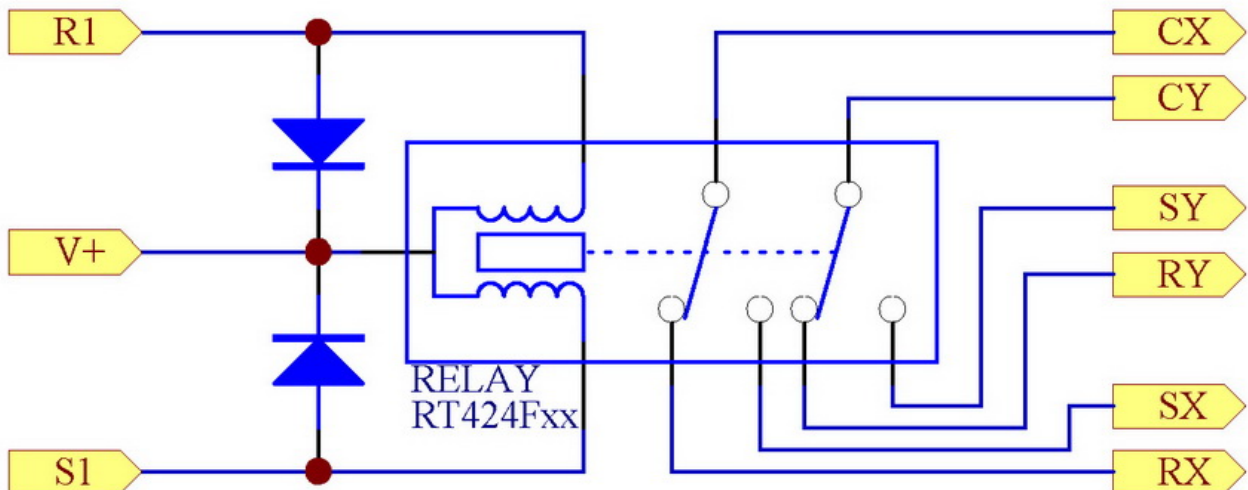

Time / State table:

SW state: 0 = disconnected, 1 = connected

Time order	V+	R Signal	S Signal	SW1 R1-C1 / C1-S1	SW2 R2-C2 / C2-S2
0	OFF	H	H	Unknown, but it keeps the state before the power off.	
1	ON	H	H		
2	ON	L	H	1 / 0	1 / 0
3	ON	H	H	1 / 0	1 / 0
4	ON	H	L	0 / 1	0 / 1
5	ON	H	H	0 / 1	0 / 1
6	OFF	H	H	0 / 1	0 / 1
7	OFF	L	H	0 / 1	0 / 1
8	OFF	H	L	0 / 1	0 / 1
9	OFF	H	H	0 / 1	0 / 1

Note:

1, R and S signal, at the same time, cannot both is Low state.

2, Due to the mechanical characteristics of the relay, I suggest that the best high state consistently greater than 300 milliseconds.

This is a simple circuit, but my description is very long-winded, I even worried that readers would misunderstand. if you still do not understand, please feel free to tell me:

Jianglily2005@gmail.com

The following two pages is the Tyco relay datasheet:

Power PCB Relay RT2 bistable

- 2 pole 8A, 2 form C (CO) contacts
- Polarized bistable version with 1 or 2 coils
- 5kV/10mm coil-contact
- Reinforced insulation

Typical applications
Battery powered equipment or applications with "memory function".



Approvals

VDE REG.-Nr. 6106, UL E214025, cCSAus 14385
Technical data of approved types on request.

Contact Data

Contact arrangement	2 form C (CO)
Rated voltage	250VAC
Max. switching voltage	400VAC
Rated current	8A, UL: 10A
Limiting continuous current	8A, UL: 10A
Limiting making current, max. 4s, duty factor 10%	15A
Breaking capacity max.	2000VA
Contact material	AgNi 90/10
Frequency of operation, with/without load	900/72000h ⁻¹
Operate/Reset time max.	10/5ms
Bounce time max., form A/form B	4/9ms

Contact ratings

Type	Contact	Load	Cycles
IEC 61810			
RT444	A (NO)	8A, 250VAC resistive, 85°C	100x10 ³
RT424	C (CO)	8A, 250VAC resistive, 85°C	30x10 ³
UL 508			
RT424	A/B (NO/NC)	10A, 250VAC, general purpose, 85°C	20x10 ³
RT424	A/B (NO/NC)	1/2hp, 240VAC, 85°C	1x10 ³
RT424	A/B (NO/NC)	Pilot duty, B300, R300, 85°C	6x10 ³

Mechanical endurance >2x10⁶ operations

Coil Data, bistable coils

	1 coil	2 coils
Magnetic system	polarized, bistable	
Coil voltage range	3 to 24VDC	
Operative range, IEC 61810	2	
Limiting voltage, % of rated coil voltage	120%	150%
Min./Max. energization duration	30ms/1min at <10% duty factor	
Coil insulation system according UL	class F	

Coil versions, bistable coil

Coil code	Rated voltage VDC	Set voltage VDC	Reset voltage VDC	Coil resistance Ω±10%	Rated coil power mW
bistable 1 coil					
A03	3	2.1	1.7	21	429
A05	5	3.5	2.8	62	403
A06	6	4.2	3.3	90	400
A12	12	8.4	6.6	360	400
A24	24	16.8	13.2	1440	400
bistable 2 coils					
F03	3	2.1	1.7	15	600
F05	5	3.5	2.8	42	595
F06	6	4.2	3.3	55	655
F12	12	8.4	6.6	240	600
F24	24	16.8	13.2	886	650

All figures are given for coil without pre-energization, at ambient temperature +23°C.
Other coil voltages on request.

Bistable coils - operation

Version	1 coil		2 coils		
Coil terminals	A1	A2	A1	A3	A2
Operate	+	-	+	-	-
Reset	-	+	-	+	+
Contact position not defined at delivery					

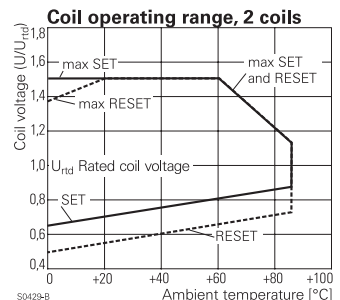
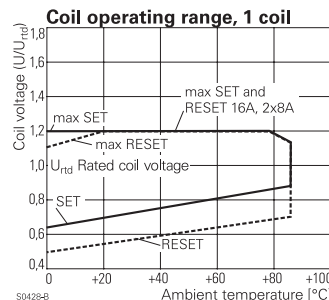
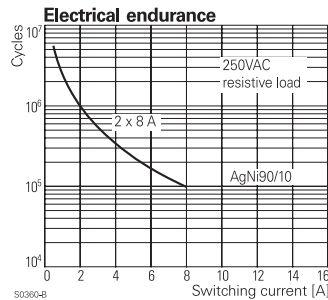
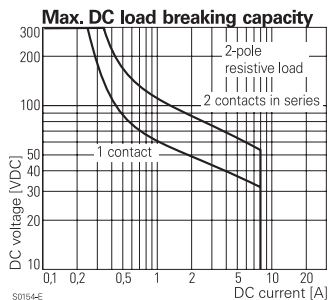

Power PCB Relay RT2 bistable (Continued)

Insulation Data

Initial dielectric strength	
between open contacts	1000V _{rms}
between contact and coil	5000V _{rms}
between adjacent contacts	2500V _{rms}
Clearance/creepage	
between contact and coil	≥10/10mm
between adjacent contacts	≥ 3/4mm
Material group of insulation parts	
	IIIa
Tracking index of relay base	
	PTI 250V

Other Data

Material compliance: EU RoHS/ELV, China RoHS, REACH, Halogen content refer to the Product Compliance Support Center at www.te.com/customer-support/rohssupportcenter

Ambient temperature	
bistable 1 coil	-10 to 85°C
bistable 2 coils	-40 to 85°C
Category of environmental protection	
IEC 61810	RTII - flux proof
Vibration/shock resistance (functional)	
opening B contact	3/5g
opening closed A contact	6/15g
Shock resistance (destructive)	
	100g

Other Data (continued)

Terminal type	PCB-THT, plug-in ¹⁾
Weight	13g
Resistance to soldering heat THT	
IEC 60068-2-20	270°C/10s
Packaging/unit	tube/20 pcs., box/500 pcs.

1) socket available for 1 coil version only, see Accessories.

Accessories

For 1 coil version, details see datasheet [Accessories Industrial Power Relay RT](#)

NOTE: indicated contact ratings and electrical endurance data for direct wiring of relays (according IEC 61810-1); for relays mounted on sockets deratings may apply.

PCB layout / terminal assignment

Bottom view on solder pins

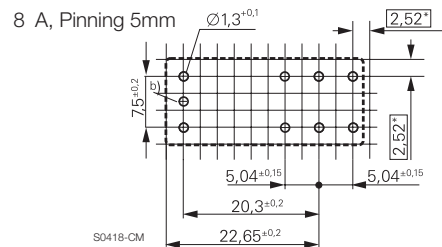

*) With the recommended PCB hole sizes a grid pattern from 2.5mm to 2.54mm can be used.

Dimensions

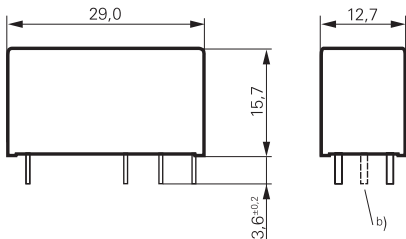

a) Indicated contact position while or after coil energization with reset voltage.

b) for 2 coil version only

2 form C (CO) contacts

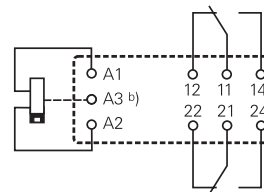

Product code structure

Typical product code **RT 4 2 4 F24**

Type	RT Power PCB Relay RT2 bistable			
Version	4 8A, pinning 5mm, flux proof	E 8A, pinning 5mm, wash tight		
Contact configuration	2 2 form C (CO) contacts			
Contact material	4 AgNi 90/10			
Coil	Coil code: please refer to coil versions table			

Product code	Version	Contacts	Contact material	Coil version	Coil	Part number
RT424A05	8A,	2 form C (CO) contacts	AgNi 90/10	Bistable 1 coil	5VDC	4-1393243-4
RT424A12	pinning 5mm, flux proof				12VDC	4-1393243-6
RT424F05				Bistable 2 coils	5VDC	5-1393243-2
RT424F12					12VDC	5-1393243-4
RT424F24					24VDC	5-1393243-6
RTE24F24	8A pinning 5mm wash tight	2 form C (CO) contacts	AgNi 90/10	Bistable 2 coils	24VDC	8-1415541-7

This list represents the most common types and does not show all variants covered by this datasheet. Other types on request.