

# CZH-LABS

## Electronics-Salon

### D-SUB Breakout Board / Interface Module Series

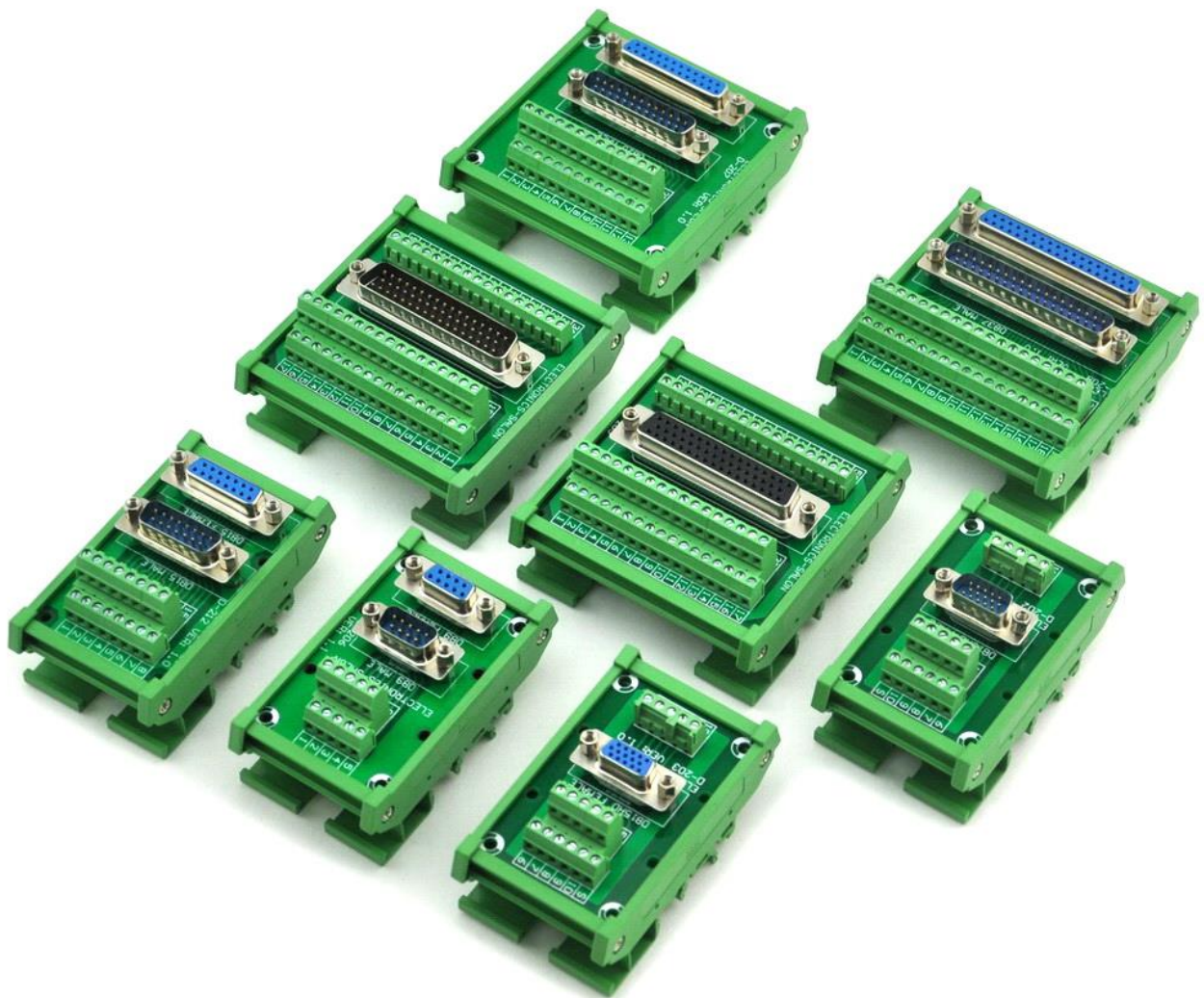

[lisheng@chunzehui.com](mailto:lisheng@chunzehui.com)

[www.electronics-salon.com](http://www.electronics-salon.com)

[www.czh-labs.com](http://www.czh-labs.com)

**Features:**

- Standard high quality D-SUB Connectors
- Miniaturized high quality screw terminal block, position pitch 3.81mm / 0.15"
- FR-4 fiber glass PCB, dual copper layers.
- Support PCB screw or DIN rail mount version selections. high quality fireproof nylon material DIN rail mount carrier (not China low quality carrier), can support width 35mm / 32mm / 15mm rail, and the carrier can be taken apart for PCB screw mount use.

**Terminal Block:**

Wire range - 26-16AWG.

Strip length - 5mm.

Screws - M2, steel, Cr3+ Zn plated.

Torque - 0.2Nm (1.7Lb-In.).

Pin header and Cage - Brass.

**Specification:**

Rated voltage: 60V.

Rated current: 1Amp / per pin.

Operating temperature: -20°C to 50°C

**Version List:**

<b>D-SUB Type</b>	<b>Part Number (SKU)</b>	<b>Mount Type</b>
DB9 Female / Male	MD-D206-1	PCB screw mount
	MD-D206T-1	DIN rail mount.
DB15 Female / Male	MD-D212-1	PCB screw mount
	MD-D212T-1	DIN rail mount.
DB25 Female / Male	MD-D207-1	PCB screw mount
	MD-D207T-1	DIN rail mount.
DB37 Female / Male	MD-D208-1	The PCB no mount holes
	MD-D208T-1	DIN rail mount.
DB15HD Male	MD-D202-1	PCB screw mount
	MD-D202T-1	DIN rail mount.
DB15HD Female	MD-D203-1	PCB screw mount
	MD-D203T-1	DIN rail mount.
DB26HD Male	MD-D1078M-1	PCB screw mount
	MD-D1078MT-1	DIN rail mount.
DB26HD Female	MD-D1078F-1	PCB screw mount
	MD-D1078FT-1	DIN rail mount.
DB44HD Male	MD-D1079M-1	PCB screw mount
	MD-D1079MT-1	DIN rail mount.
DB44HD Female	MD-D1079F-1	PCB screw mount
	MD-D1079FT-1	DIN rail mount.
DB50 Male	MD-D204-1	PCB screw mount
	MD-D204T-1	DIN rail mount.
DB50 Female	MD-D205-1	PCB screw mount
	MD-D205T-1	DIN rail mount.
DB62HD Male	MD-D1080M-1	PCB screw mount
	MD-D1080MT-1	DIN rail mount.
DB62HD Female	MD-D1080F-1	PCB screw mount
	MD-D1080FT-1	DIN rail mount.
DB78HD Male	MD-D1081M-1	PCB screw mount
	MD-D1081MT-1	DIN rail mount.
DB78HD Female	MD-D1081F-1	PCB screw mount
	MD-D1081FT-1	DIN rail mount.

# MD-D206, DB9 Female / Male Schematic and Size

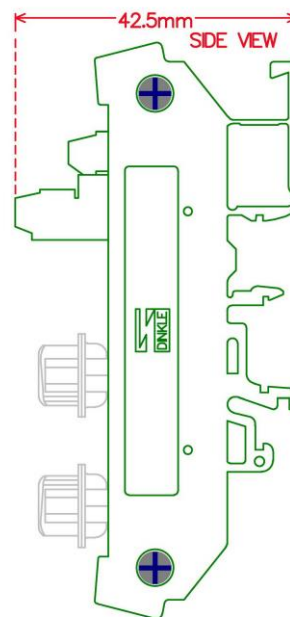
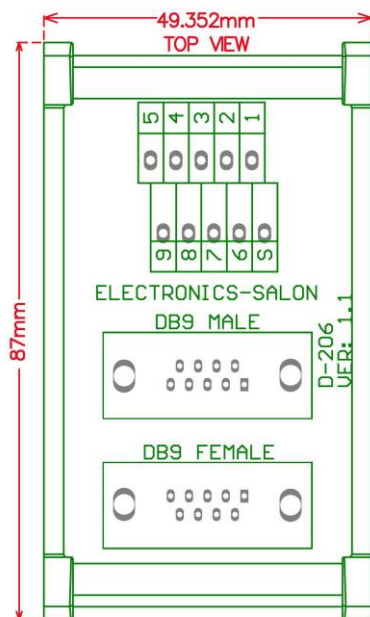
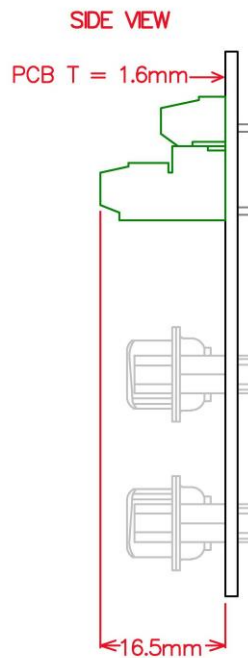
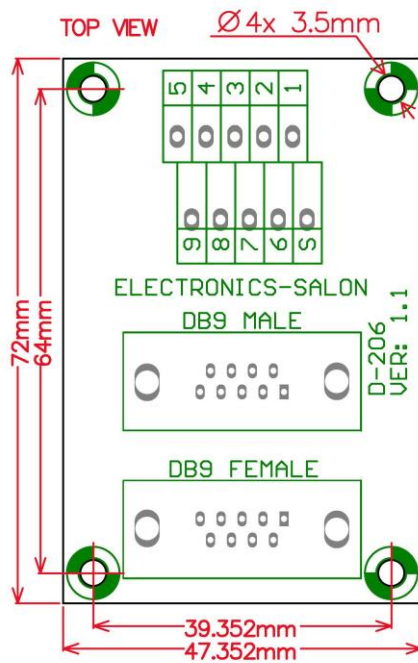
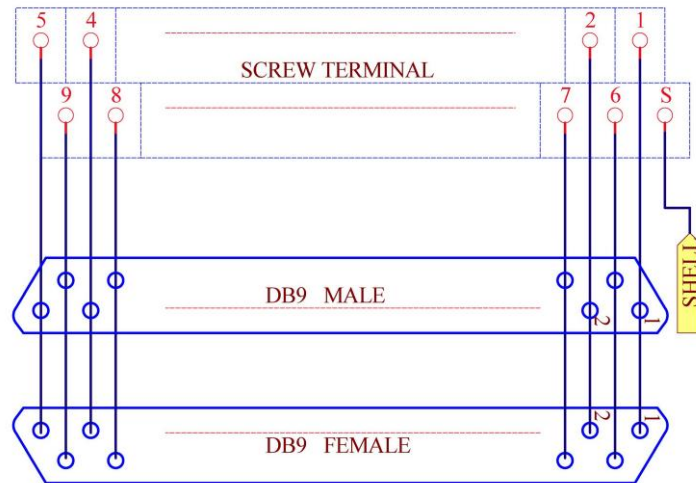

# MD-D212, DB15 Female / Male Schematic and Size

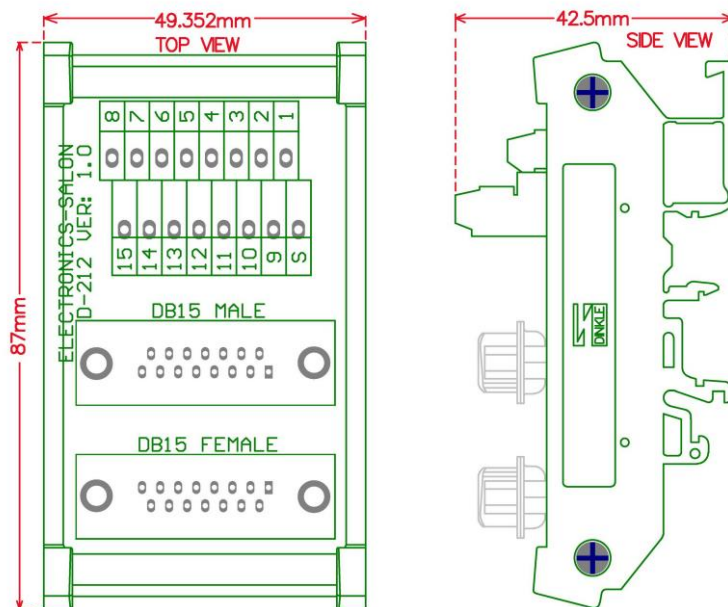
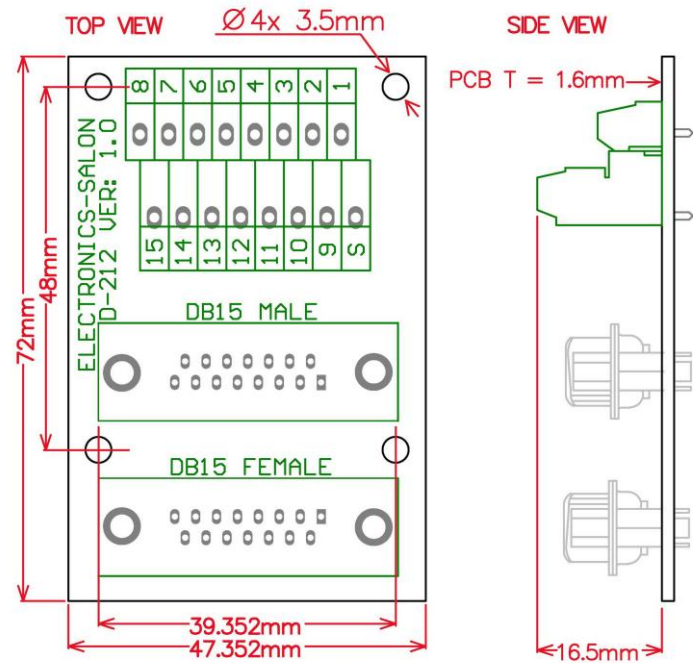
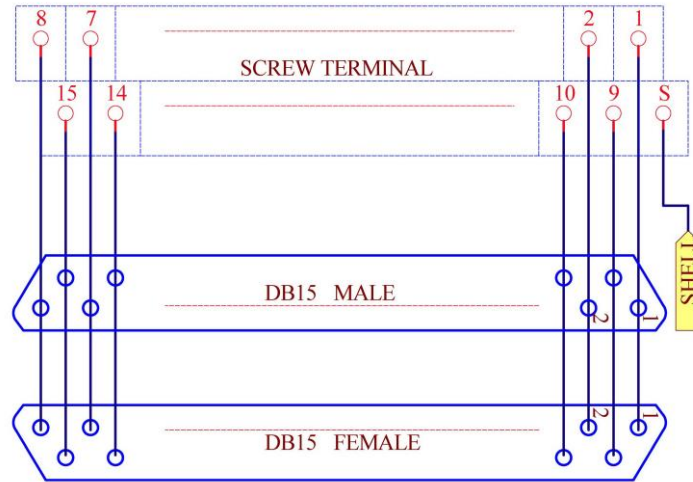

# MD-D207, DB25 Female / Male Schematic and Size

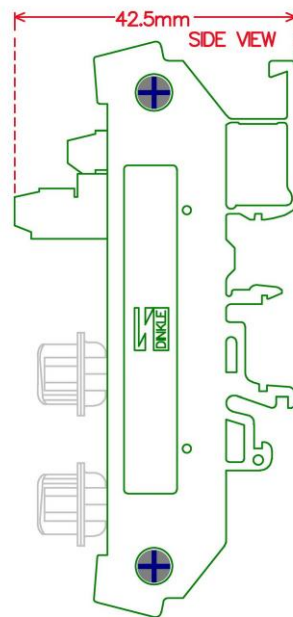
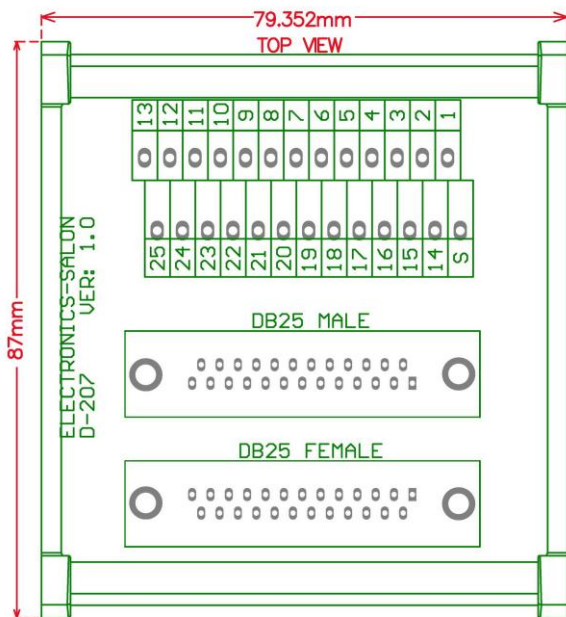
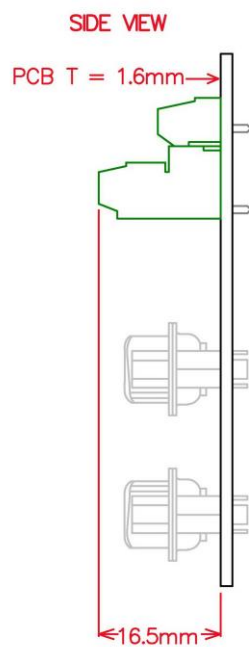
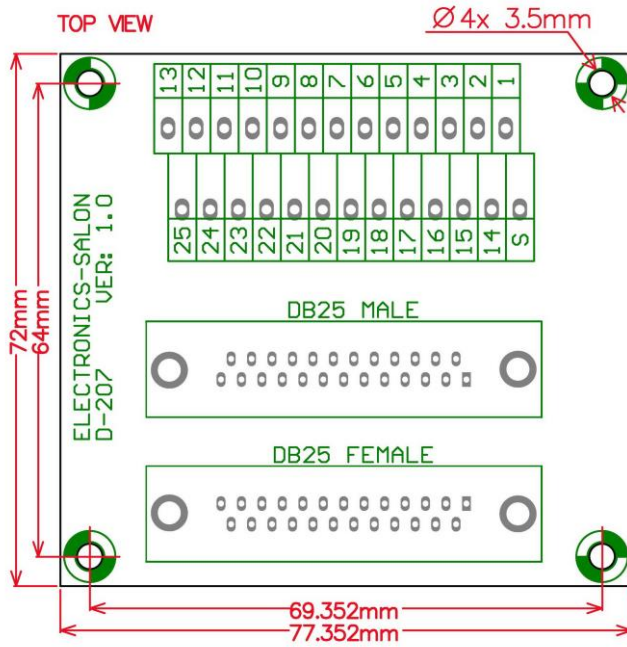
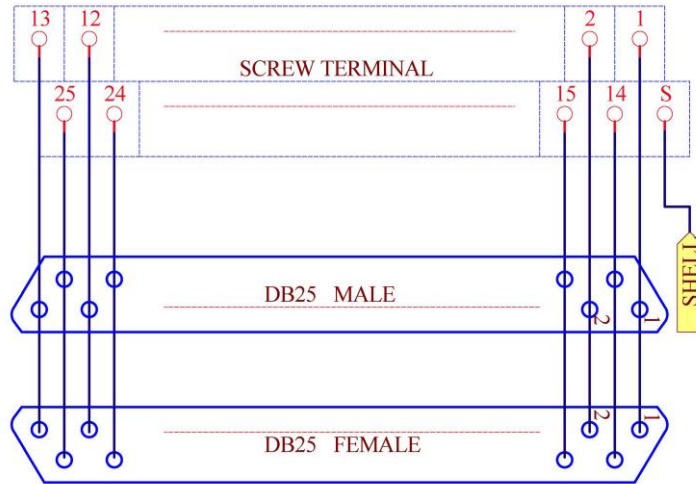

# MD-D208, DB37 Female / Male Schematic and Size

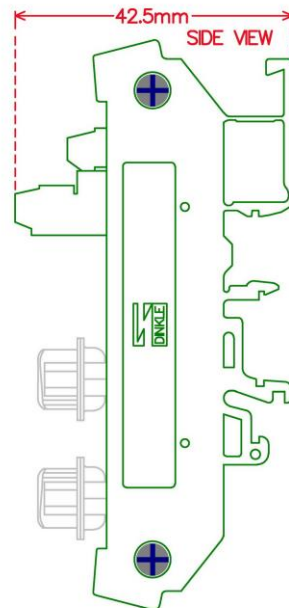
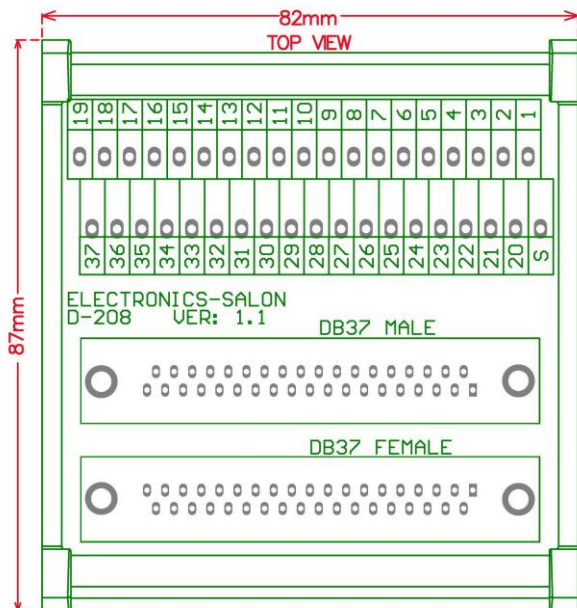
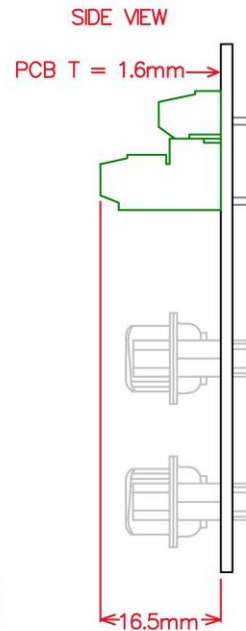
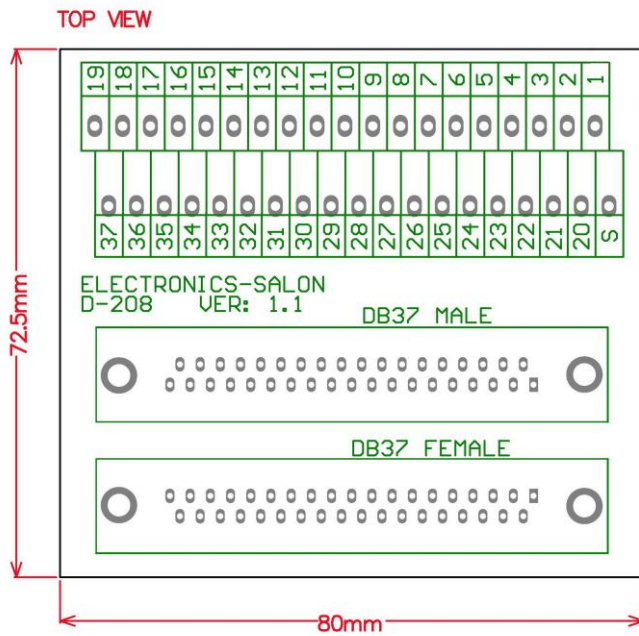
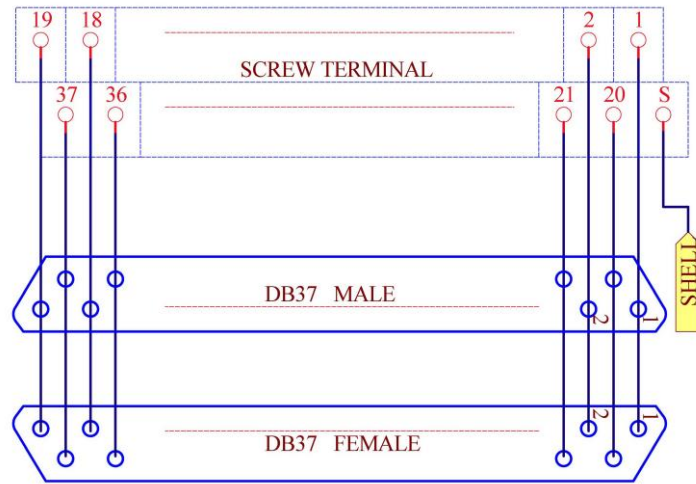

# MD-D202, DB15HD Male Schematic and Size

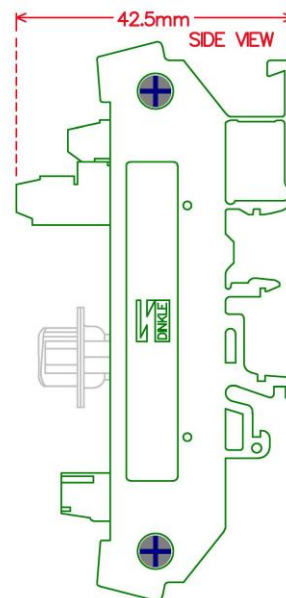
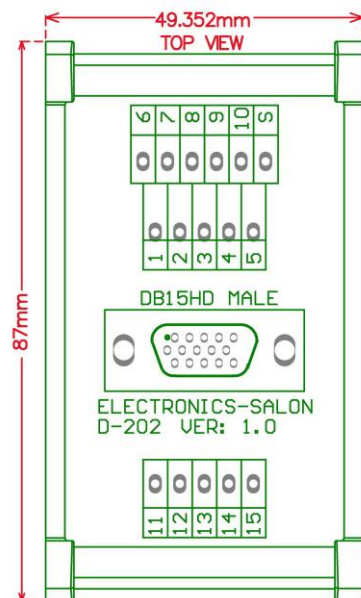
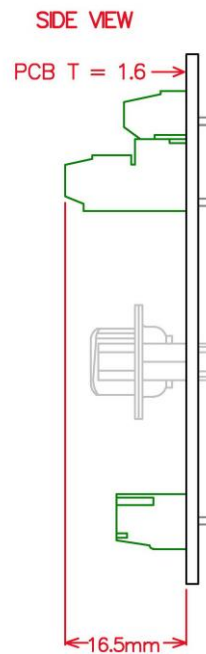
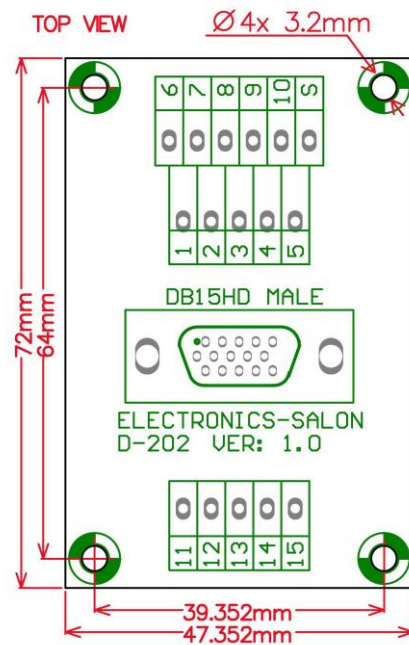
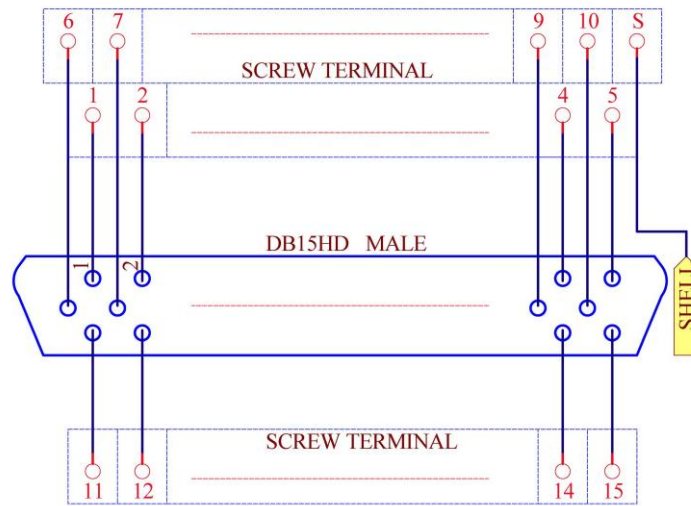



# MD-D203, DB15HD Female Schematic and Size

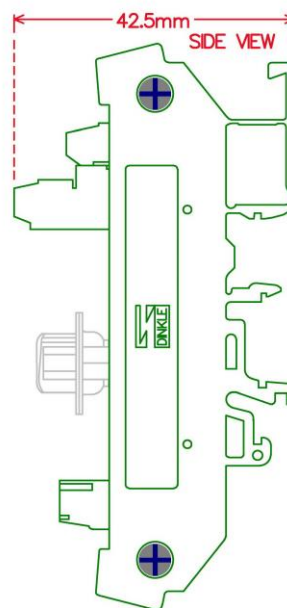
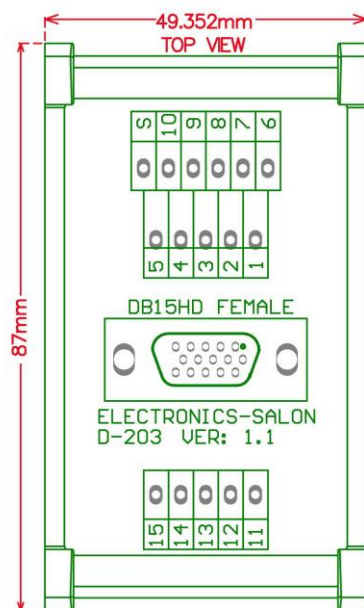
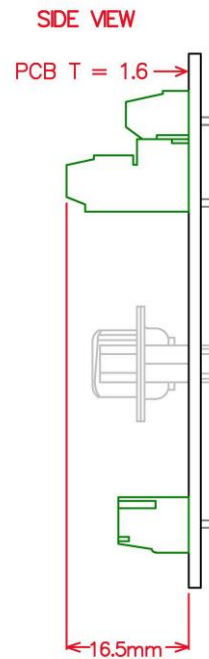
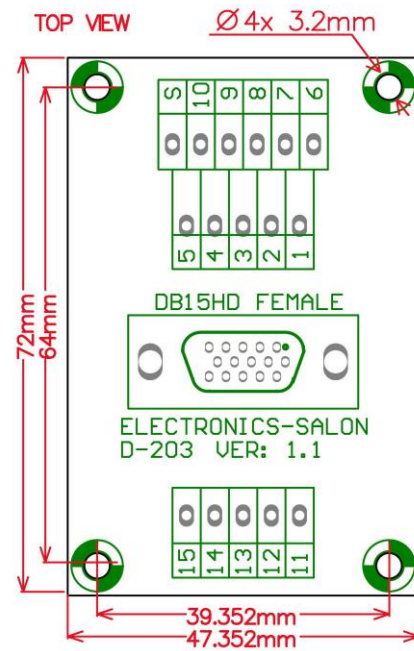
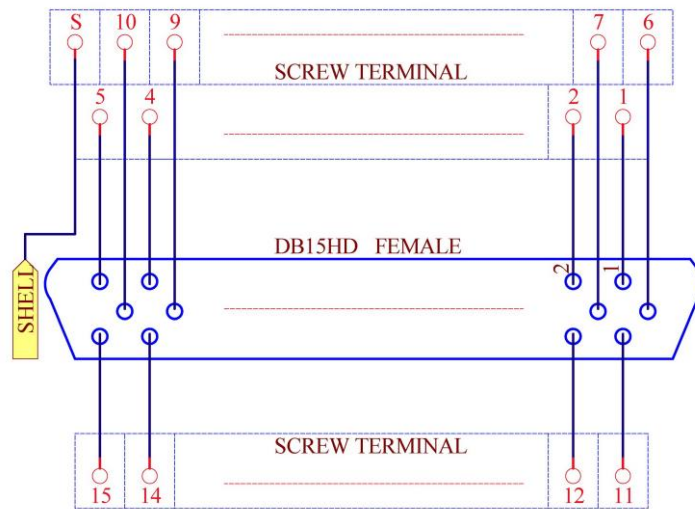

# MD-D1078M, DB26HD Male Schematic and Size

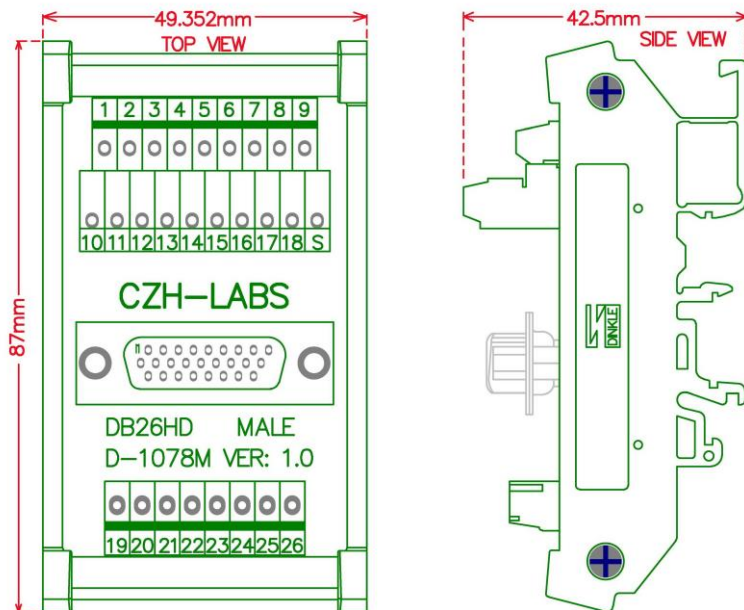
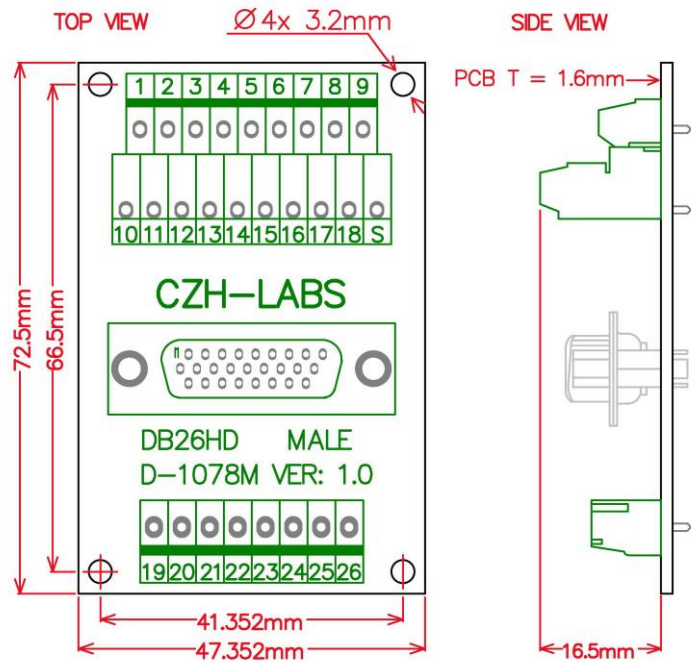
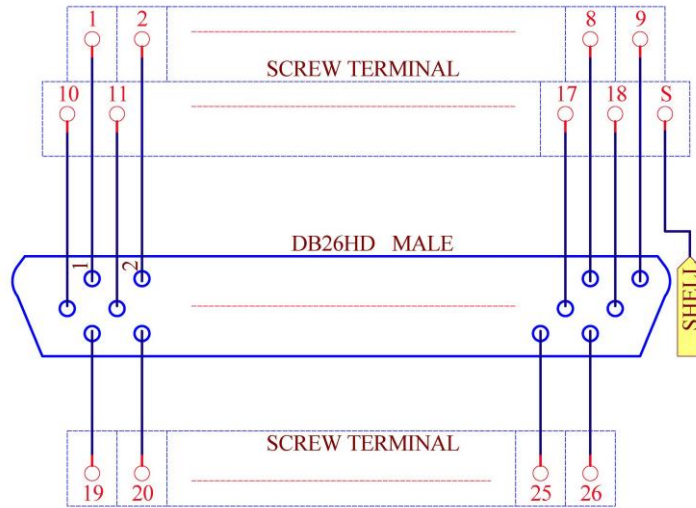

# MD-D1078F, DB26HD Female Schematic and Size

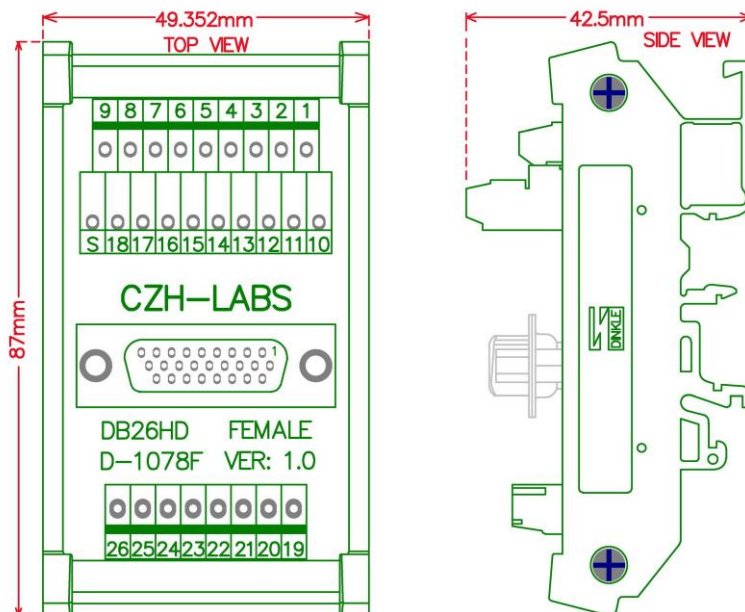
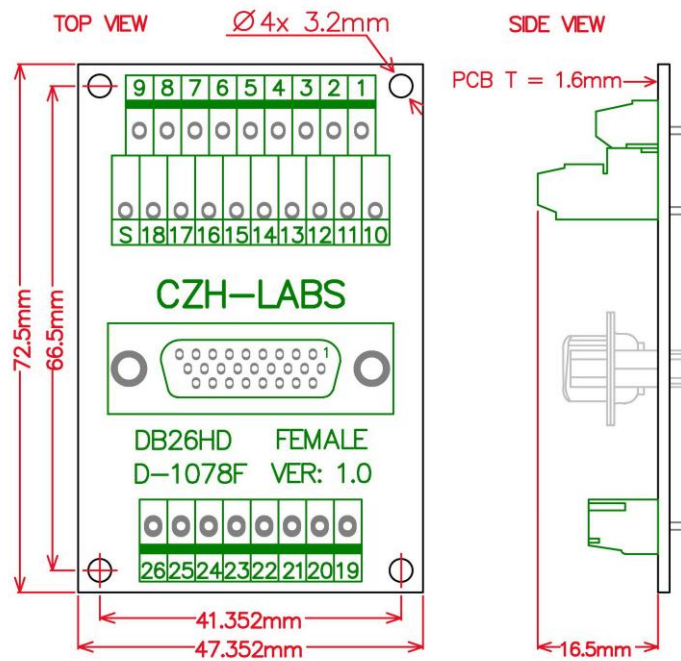
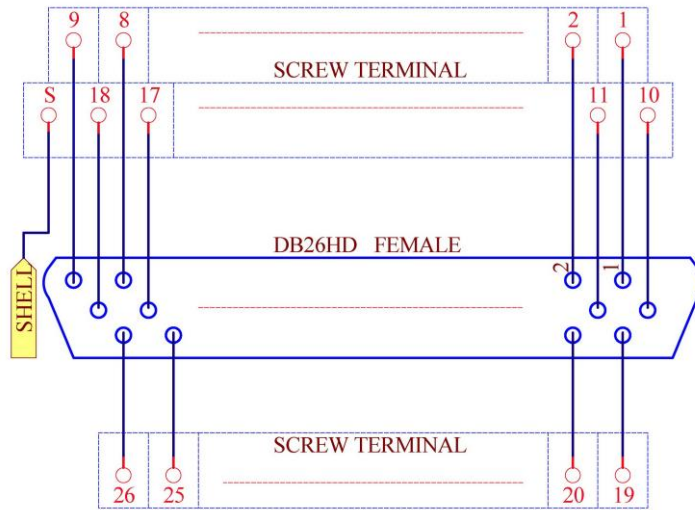

# MD-D1079M, DB44HD Male Schematic and Size

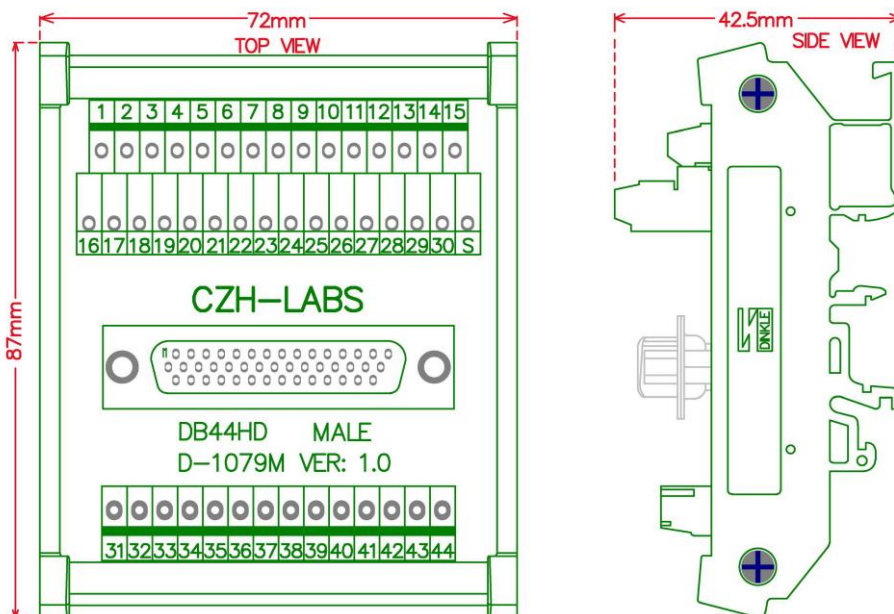
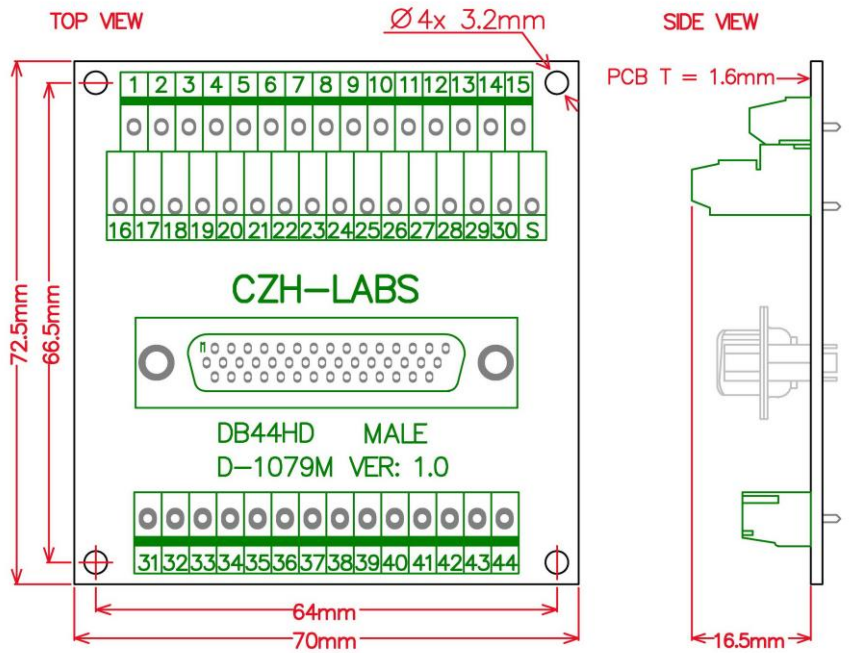
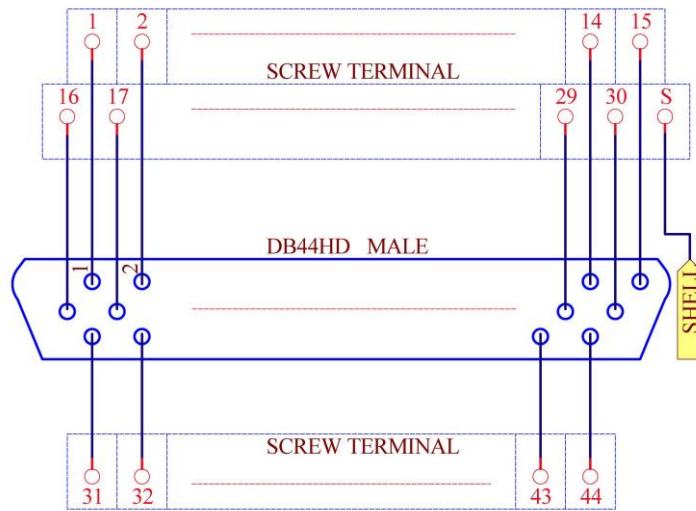

# MD-D1079F, DB44HD Female Schematic and Size

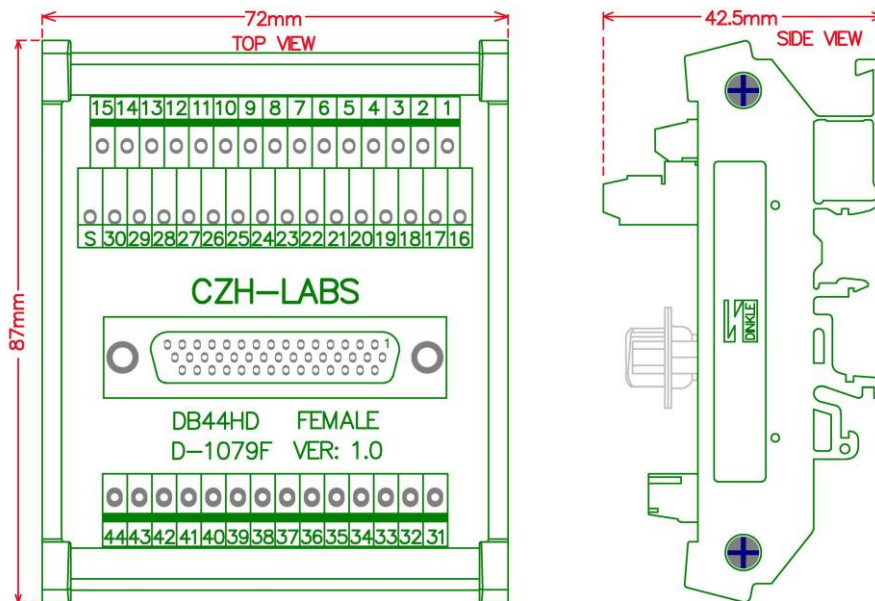
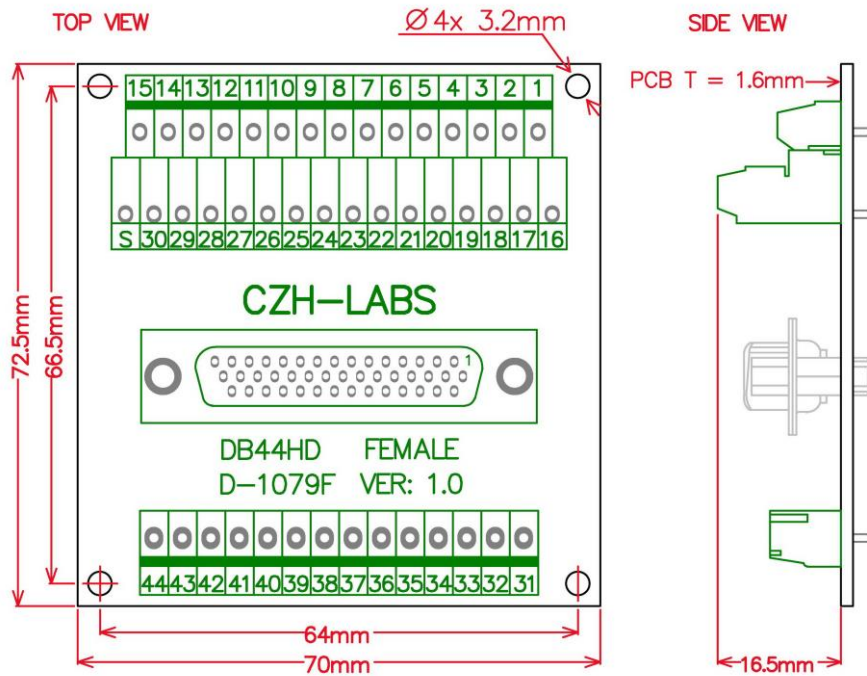
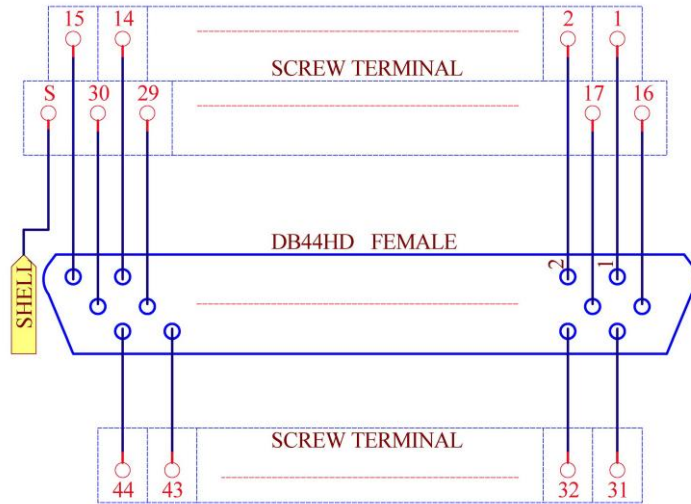

# MD-D204, DB50 Male Schematic and Size

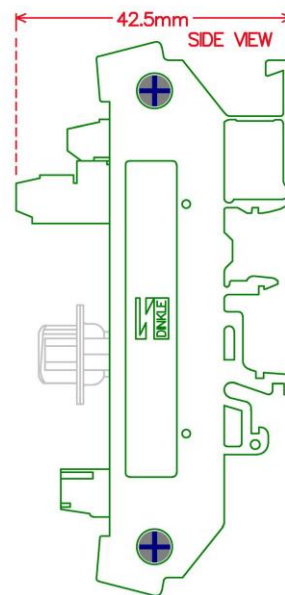
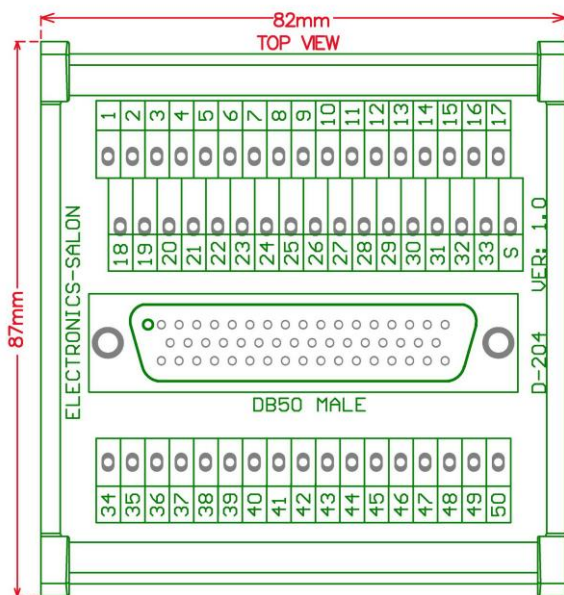
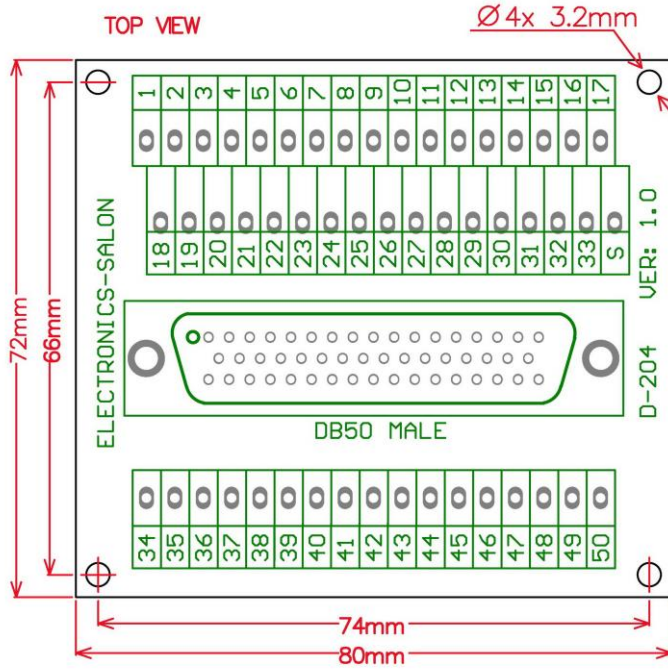
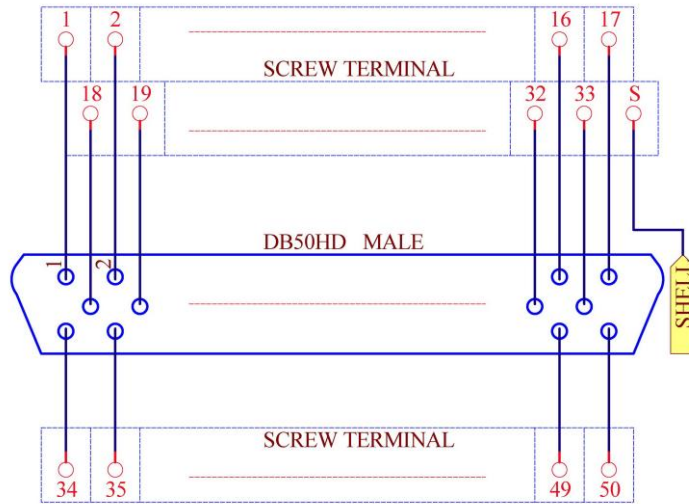

# MD-D205, DB50 Female Schematic and Size

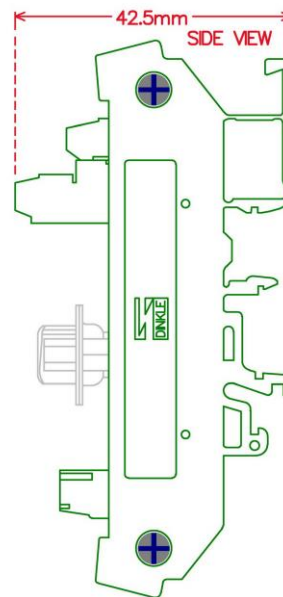
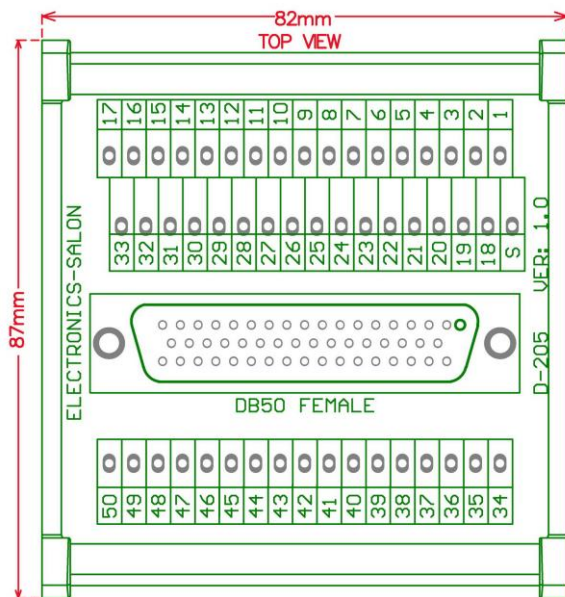
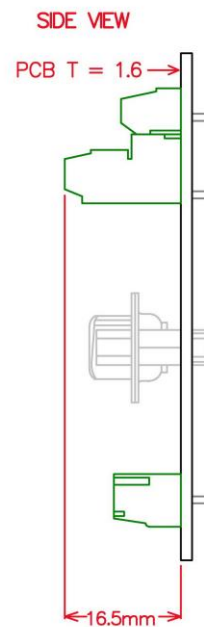
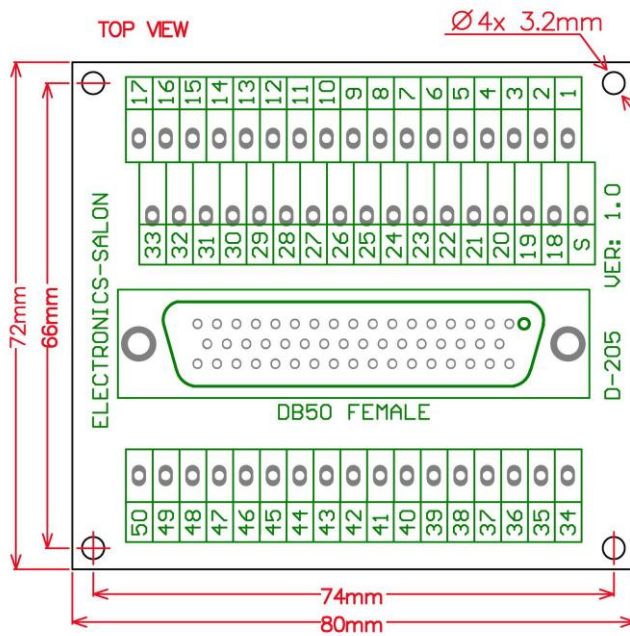
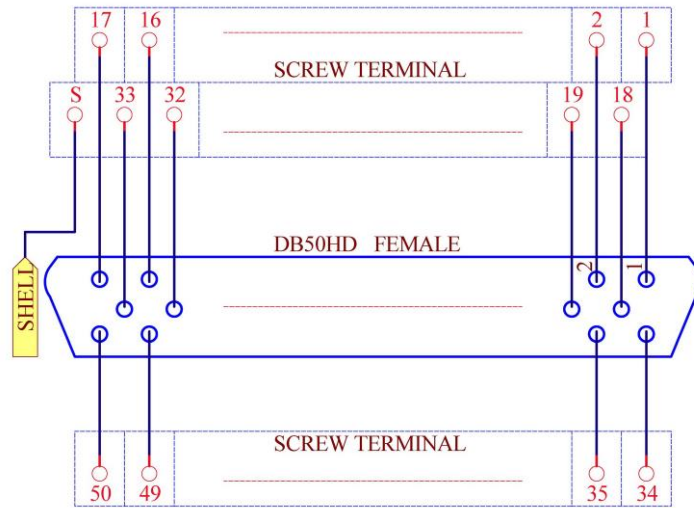

# MD-D1080M, DB62HD Male Schematic and Size

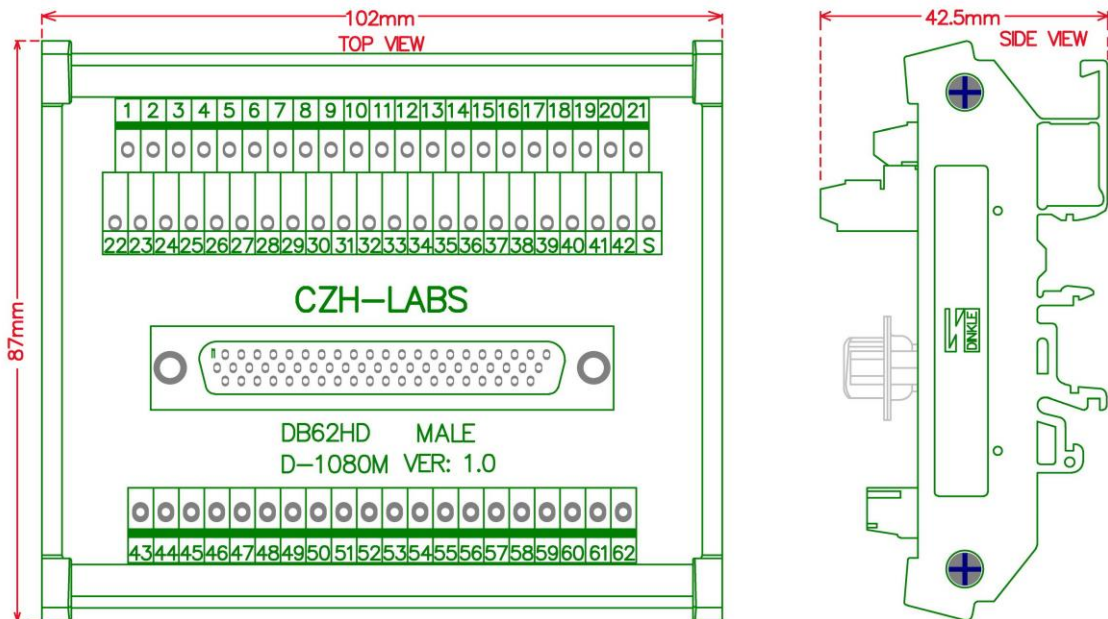
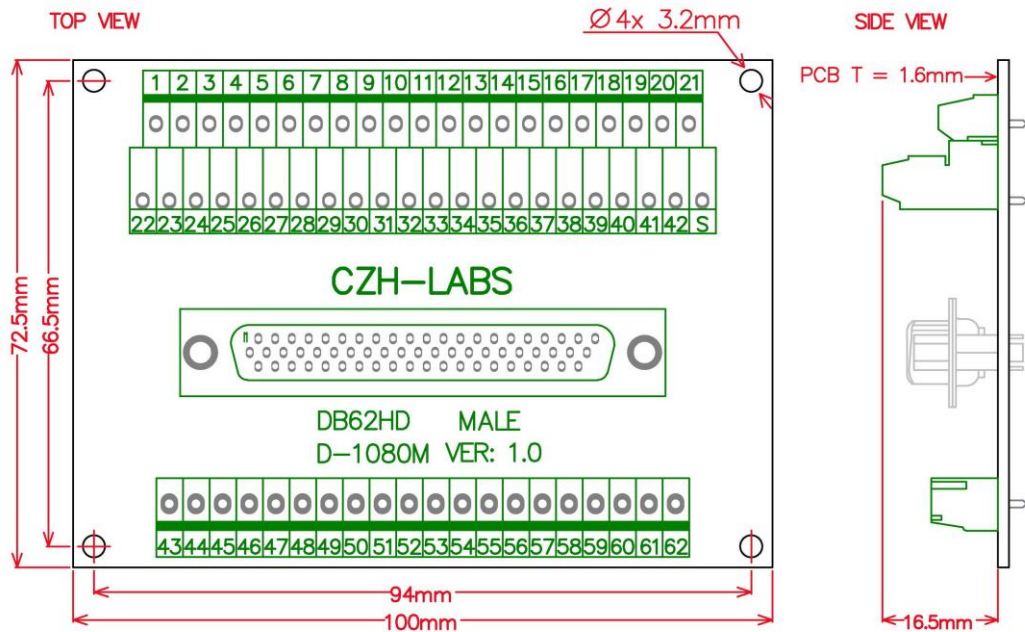
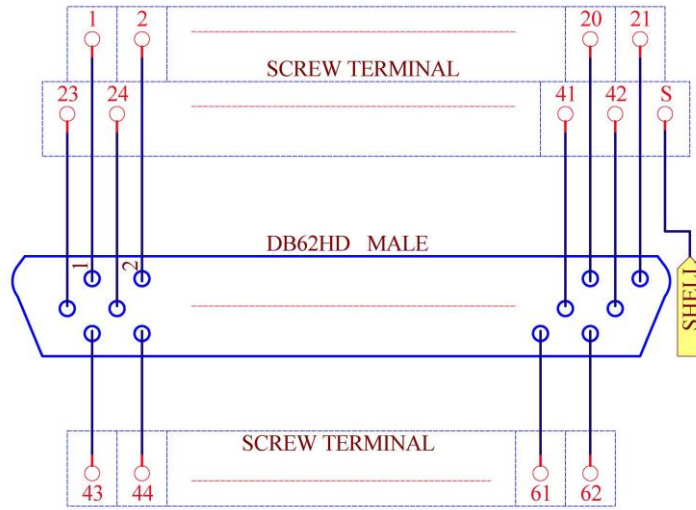



# MD-D1080F, DB62HD Female Schematic and Size

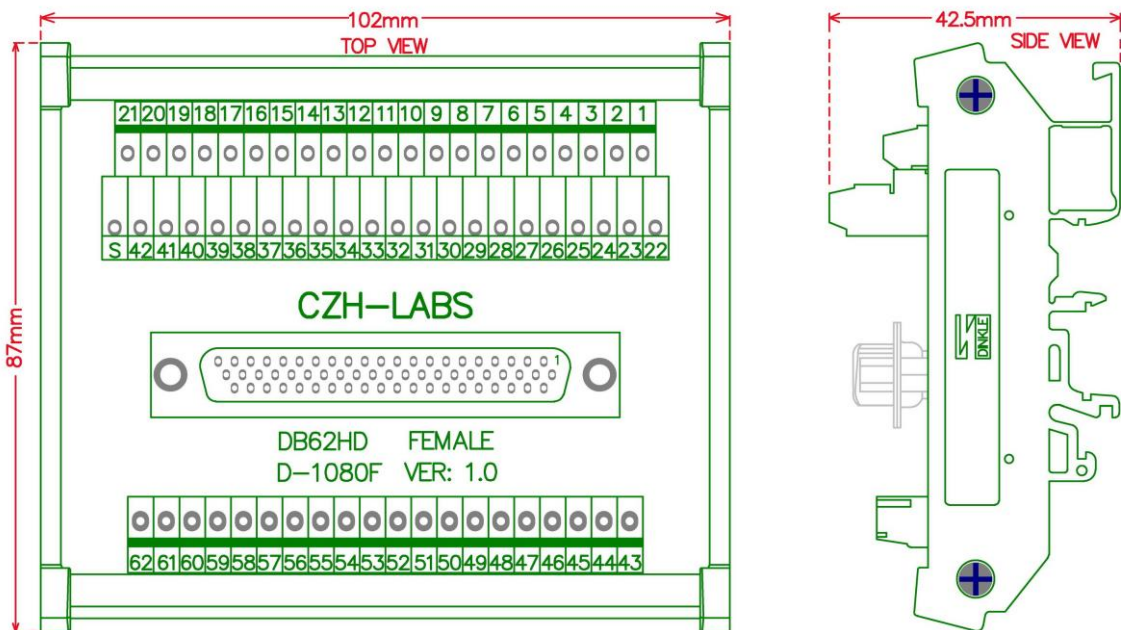
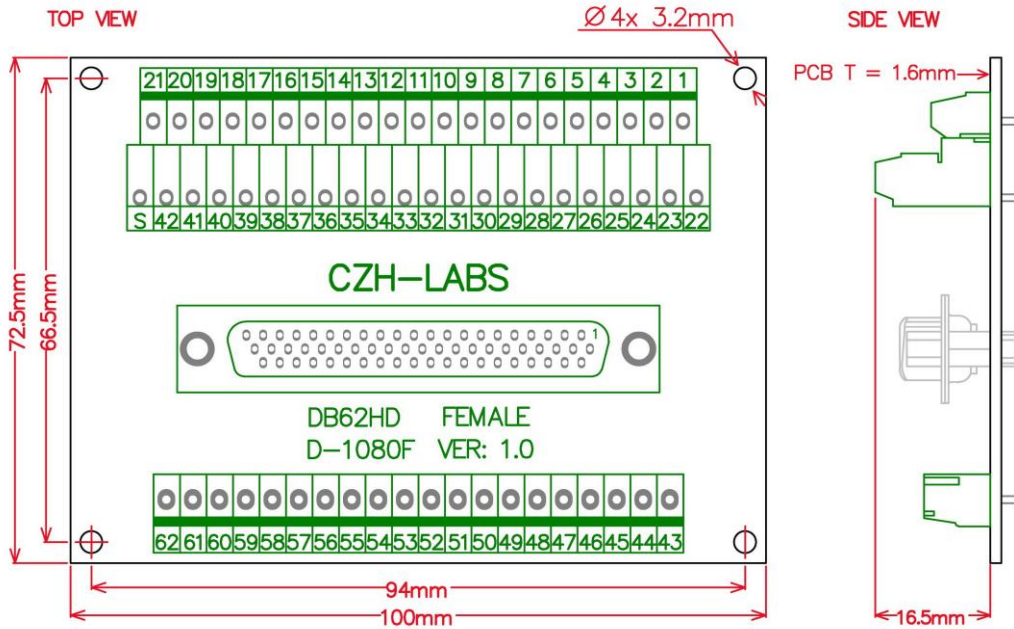
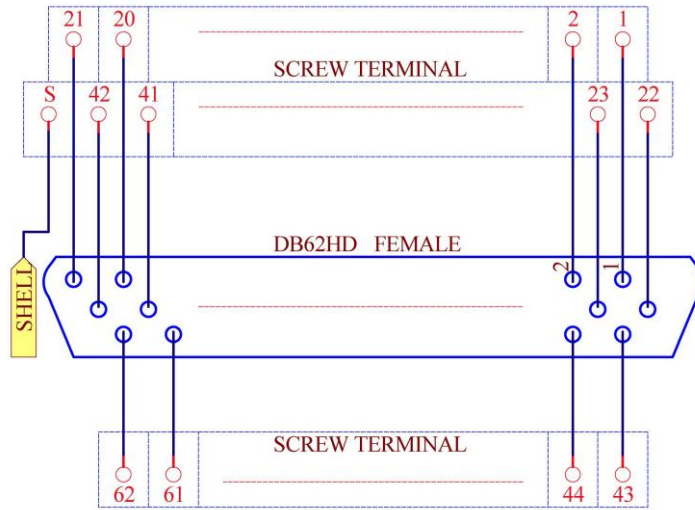

# MD-D1081M, DB78HD Male Schematic and Size

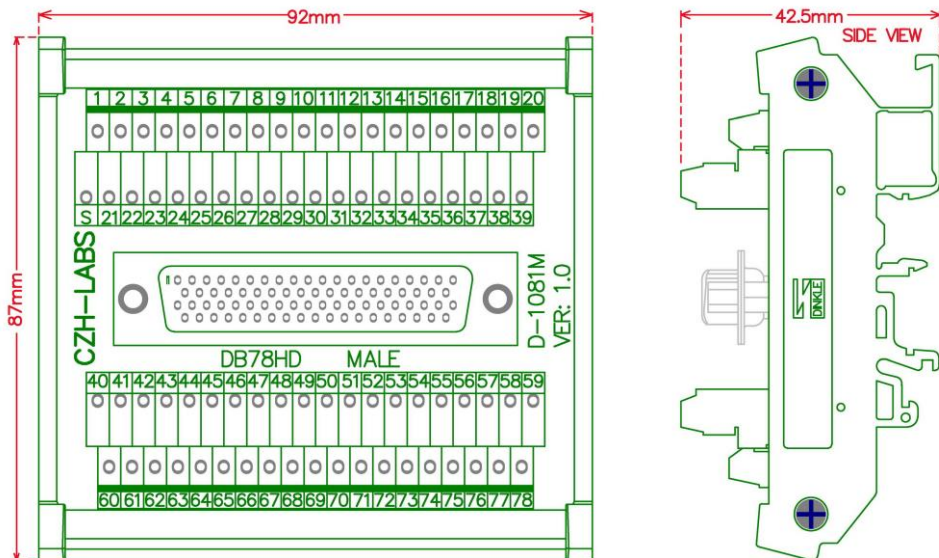
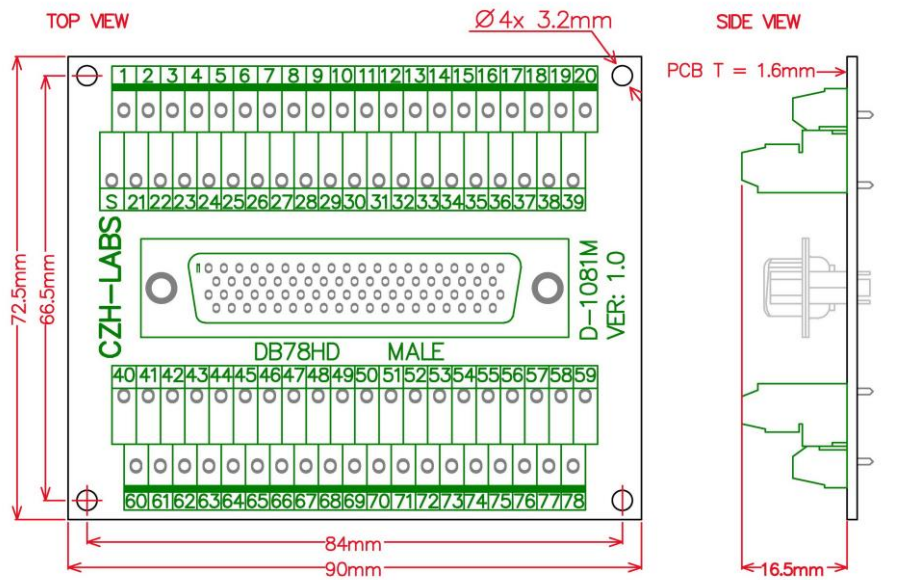
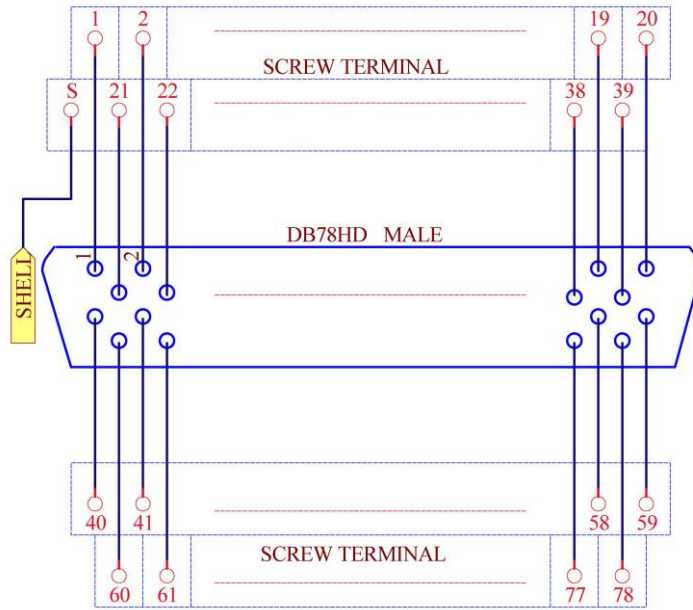

# MD-D1081F, DB78HD Female Schematic and Size

